

THIS DOCUMENT IS THE PROPERTY OF
KEYSTONE ELECTRONICS CORP. AND
SHALL NOT BE REPRODUCED, DISTRIBUTED
OR USED AS A BASIS FOR MANUFACTURE
WITHOUT PRIOR WRITTEN PERMISSION
FROM KEYSTONE ELECTRONICS CORP.

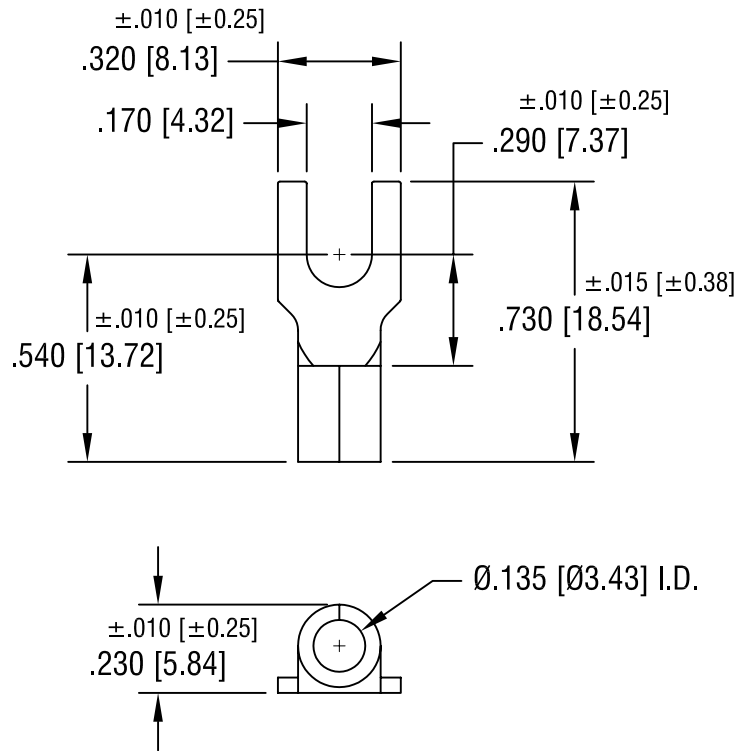

NOTE:

1. ACCOMMODATES WIRE RANGE 12/10 AWG

KEYSTONE ELECTRONICS CORP.			
ASTORIA, N.Y. 11105-2017			
PART NAME		BLOCK SPADE TERMINAL	
MATERIAL		.040 [1.02] TH'K COPPER	
FINISH		DRN BY	DATE
TIN PLATE		BOONE	10.22.07
		APP'D	SCALE
		LN	2X
TOLERANCES	INCH [MM]	CODE	DWG NO.
DECIMAL	$\pm .005$ [± 0.15]	C/M	8225
ANGULAR	$\pm 1^\circ$	UNLESS OTHERWISE SPECIFIED	

DATE	DESCRIPTION	REV.